

I-PRO 2 INSULATED BOWLS, ELECTRONICAL CONTROL AND N-UV SANITIZING SYSTEM



I-PRO 2 INSULATED BOWLS, ELECTRONICAL CONTROL AND N-UV SANITIZING SYSTEM

**Ref: 562465
(IPRO2EUV)**

SLUSH MACHINE I-PRO 2 E UV STD 230/50 WHITE - GAS R452A

General Features

I-PRO 2 ELECTRONIC UV is a professional slush machine with n. 2 I-Tank insulated bowls, 11 litres each, electronic control and n-UV sanitizing system.

The numerous patents and innovations make this equipment one of the most advanced slush machines in the world.

The I-PRO UV is the first slushie machine that has equipped with a n-UV LED light system which sanitizes the product inside the tank, ensuring the quality and wholesomeness of the dispensed product.

This equipment has the I-Tank insulated tank as standard.

The look is modern and eye-catching, thanks to the LED-light system that illuminates the product inside the tank.

The shape of the bowls allows a natural mixing process to ensure an optimum consistency of the product.

I-PRO ELECTRONIC helps to save energy and to reduce CO2 emissions; a stand-by mode is automatically activated when the product reaches the right consistency.

The machine can be programmed daily or weekly.

Bowls work independently, and thanks to this is it possible to dispense different product with the one equipment at the same time, like: slushies, milkshakes, cold drinks and/or frozen cocktails.

The n-UV sanitizing system makes this equipment particularly suitable for dairy-based products.

I-PRO is an ideal slush machine for bars, amusement parks, multiplex, fast food chains, kiosks, restaurants, water parks and much more

SPM

I-PRO 2 INSULATED BOWLS, ELECTRONICAL CONTROL AND N-UV SANITIZING SYSTEM

Specifications

- I-PRO is an ideal slush machine for bars, amusement parks, motorway restaurants, fast food chains, kiosks, restaurants, water parks and much more.
- It is possible to customize the graphics on the front, on the lid and on the back (subject to negotiation).
- I-PRO ELECTRONIC is equipped with an integrated diagnostic system which signals any problems directly on the display.
- The I-PRO ELECTRONIC is a professional slush machine automatically switches from "production" mode to "stand-by" mode when it reaches the selected product consistency, guaranteeing energy savings and a reduction in CO2 emissions.
- The special shape of the I-PRO tanks, 11 litres of finished product each and LED-lighted, allows for a natural mixing effect which guarantees perfect consistency of the product.
- Thanks to the n-UV sanitizing system, this equipment is particularly suitable for dairy-based products.
- Optionals available: autofill lid (pre-mix or post-mix) for the automatic filling of the tanks, and the LED-backlighted front panel.
- The bowls work independently, and thanks to this it is possible to dispense different product with the one equipment at the same time, for example: slushies, milkshakes, cold drinks and/or frozen cocktails.

Construction

- The patented I-Tank insulated bowl reduces the impact of ambient temperature on the product, improving its cooling efficiency and guaranteeing energy and cost savings.
- The electronic keypad allows you to program the slush machine daily or weekly.
- Slush machine with 2x11-litres insulated bowls
- Exclusive n-UV LED system for bowl sanitation that reduces bacterial proliferation, ensuring a wholesome, high quality dispensed product.

SPM

www.spm.drink-systems.com
infospm@electroluxprofessional.com

I-PRO 2 INSULATED BOWLS, ELECTRONICAL CONTROL AND N-UV SANITIZING SYSTEM

Electric

Supply voltage:	220-240 V / 1 ph / 50 Hz
Electrical power max.:	0.95 kW
Current consumption:	4.7 Amps
Plug type:	CE-SCHUKO

Key Information:

Number of bowls:	2
Bowl's capacity:	ISO 9001; ISO 14001 lt
Control board:	Electronic
Dimensions, Width:	400 mm
Dimensions, Depth:	580 mm
Dimensions, Height:	870 mm
Net weight:	60 kg
Cooling system:	AIR

Refrigeration Data

Refrigerant gas:	R452A
Sustainability	
Current consumption:	4.7 Amps
562465 (I-PRO2EUV)	
Refrigerant type:	R452A

Certifications



The company reserves the right to make modifications to the products without prior notice. All information correct at time of printing.

2024.04.10

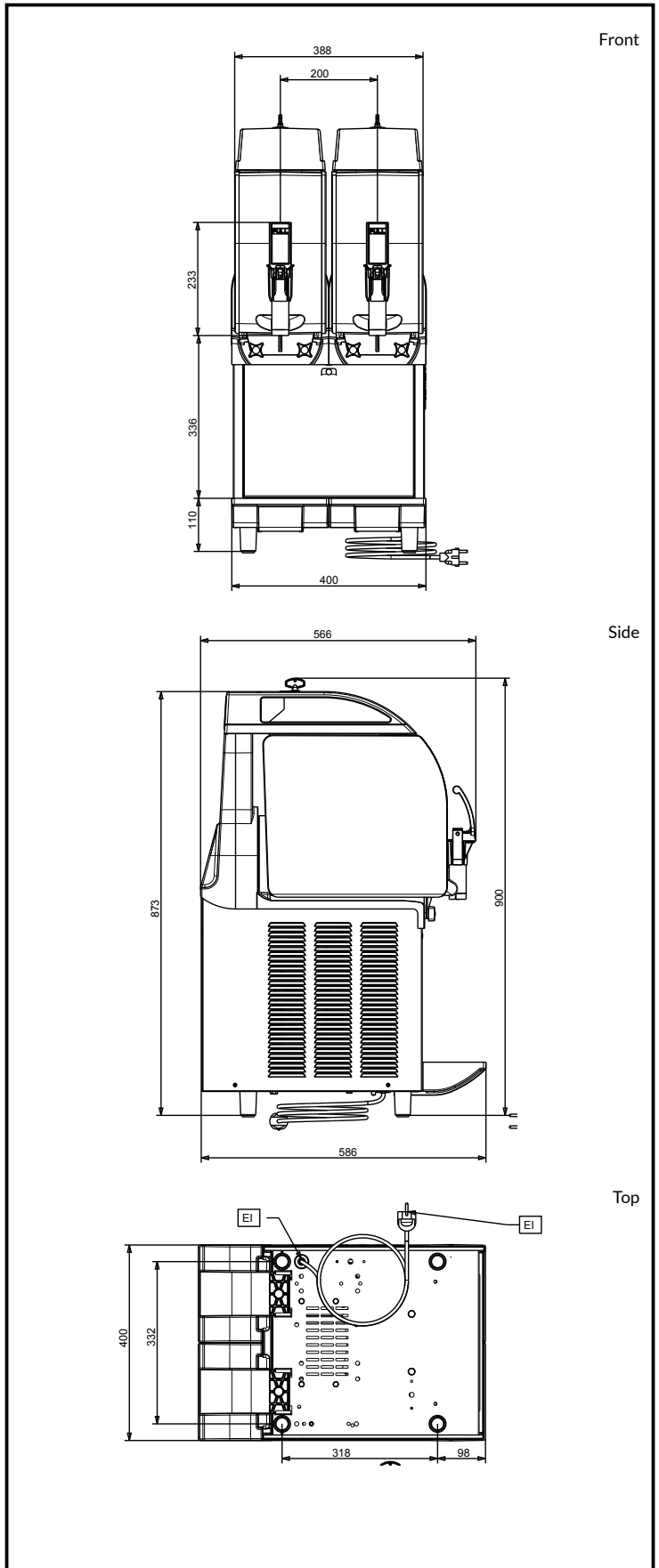

SPM

www.spm.drink-systems.com
infospm@electroluxprofessional.com